

fontealta

in&out steel concept

Con rubinetti acqua calda e fredda
With hot and cold water taps
Avec mélangeur eau chaude et froide
Mit Warm- und Kaltwasserventil
Con grifos para agua caliente y fría

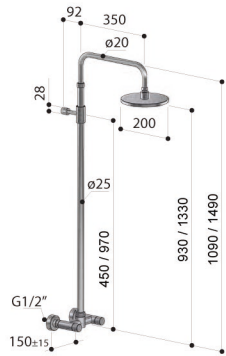

W50

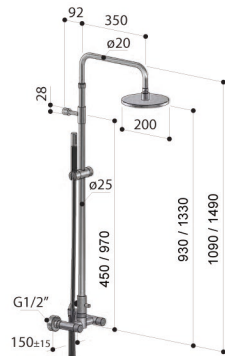

W50.E

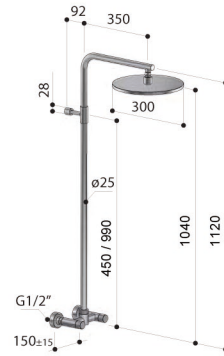

W60

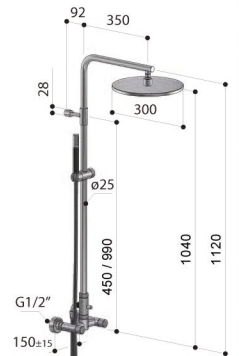

W60.E

Con miscelatore monocomando
With single-lever mixer
Avec mitigeur monocommande
Mit Einhebelmischer
Con mezclador monomando

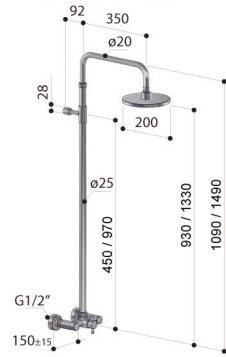

W53

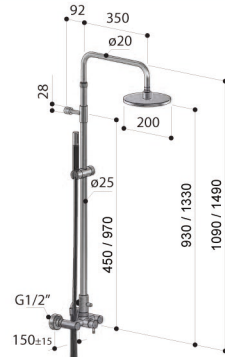

W53.E

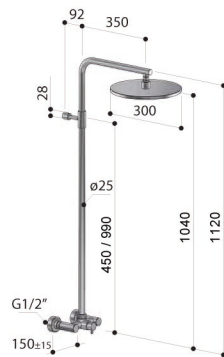

W63

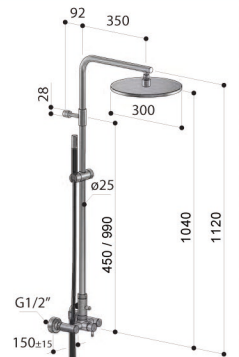

W63.E

Con presa d'acqua
With wall coupling
Avec coude de sortie
Mit Wandanschlußbogen
Con codo mural

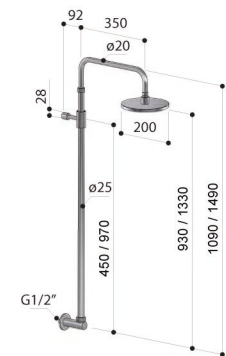

W51

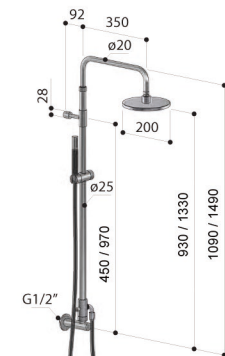

W51.E

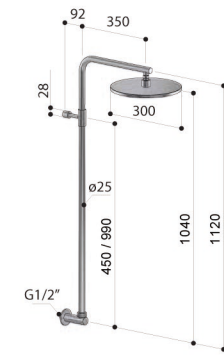

W61

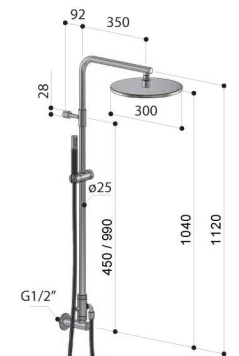

W61.E

Con rubinetto acqua fredda
With cold water tap
Avec robinet eau froide
Mit Kaltwasserventil
Con grifo agua fría

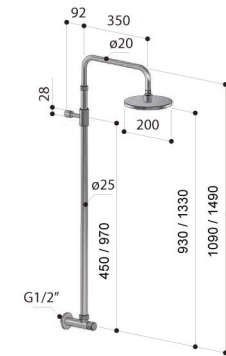

W52

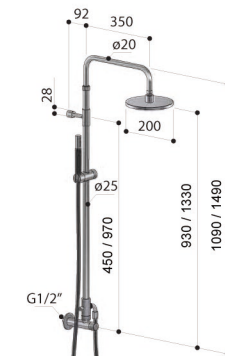

W52

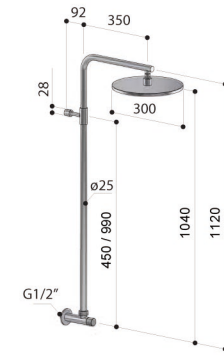

W62

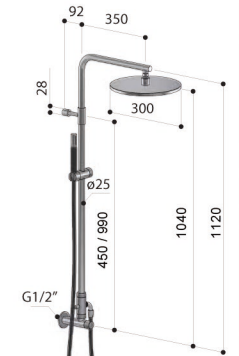

W62.E

BEFORE STARTING / AVANT DE COMMENCER / VOR DEM START / PRIMA DI INIZIARE / VOORDAT U BEGINT MET						
P bar	MAX 5 1 MIN	3	T °C	MAX 80	60 45	

W50
W50.E

W53
W53.E

W60
W60.E

W63
W63.E

1



2



3

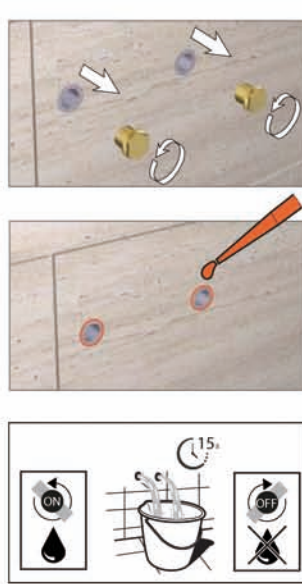

4

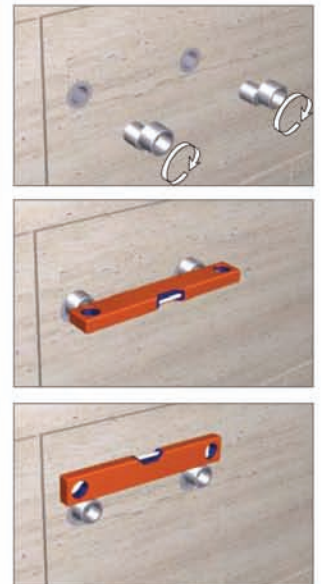

5

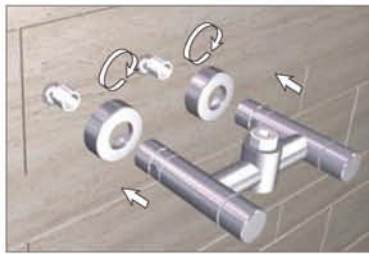

6



7

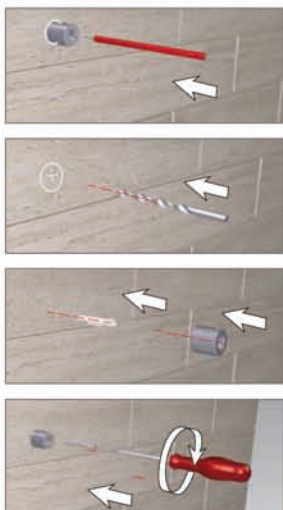

8

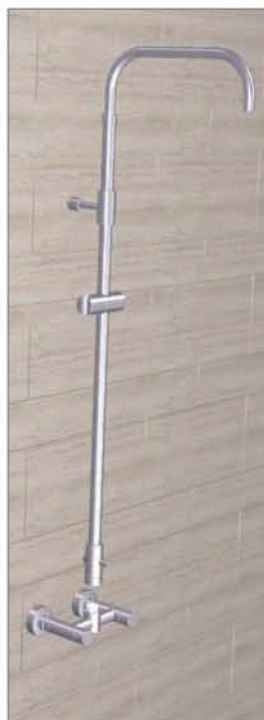

9



W51
W51.E

W52
W52.E

W61
W61.E

W62
W62.E

1



2



3

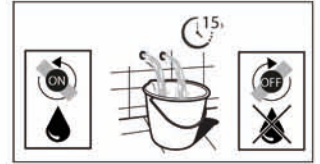

4

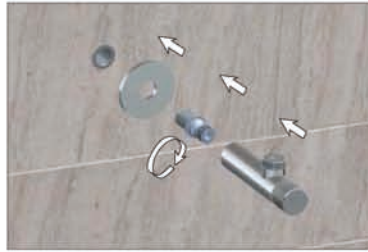

5



6

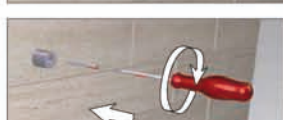

7



8



Manutenzione - Maintenance - Entretien - Erhaltung - Mantenimiento

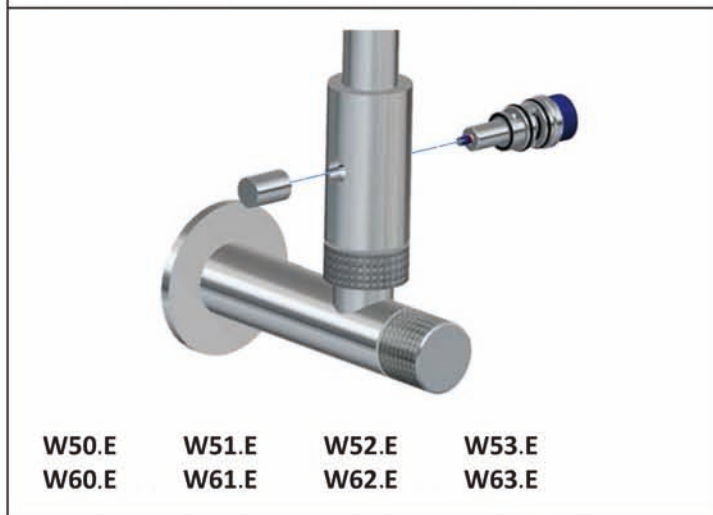
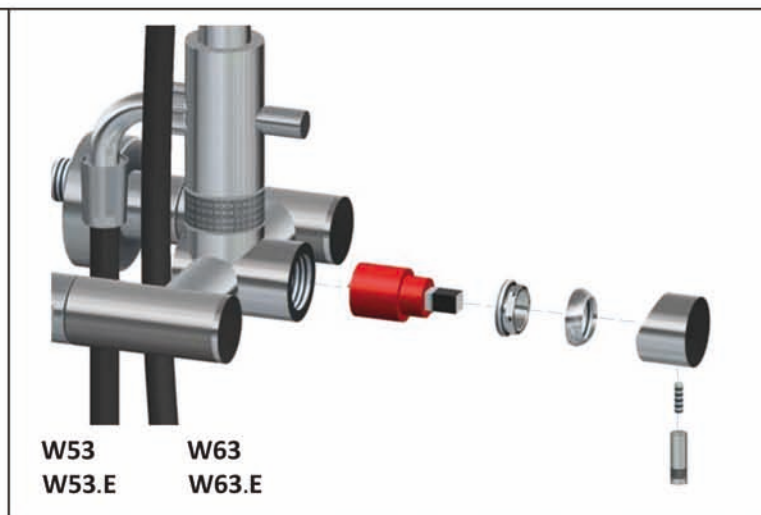
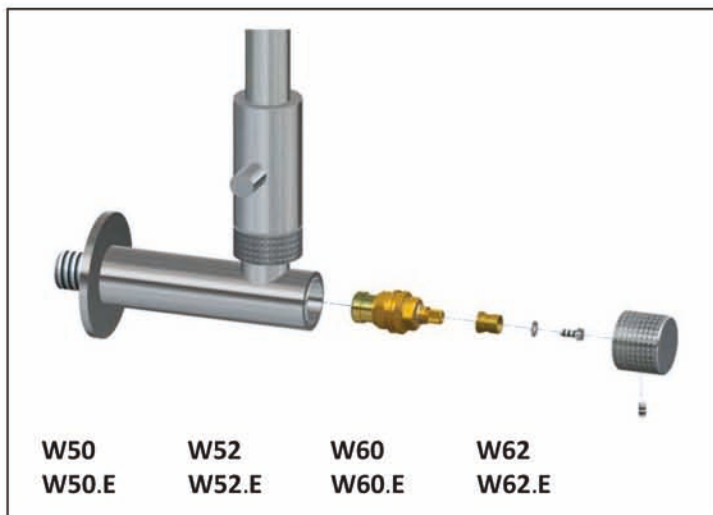

AISI 316 L		
CLEANING / NETTOYAGE / REINIGUNG / PULIZIA / REINIGING		
WATER ✓	LIQUID SOAP ✓	MICROFIBER ✓
ROUGH SPONGE ✗	ACID/ABRASIVE DETERGENT ✗	Hydrochloric acid Muriatic Acid Hydrofluoric Acid Chlorine water Bleaching solution

ISTRUZIONI SPECIALI

In ambienti esterni particolarmente aggressivi (alta salinità, esposizione al gelo ecc.) si consiglia di:

- rimuovere soffioni, vitoni e cartucce miscelatrici durante la stagione fredda
- effettuare la lucidatura almeno tre volte l'anno o tre volte durante il periodo di utilizzo (all'inizio, a metà e a fine del periodo)

SPECIAL INSTRUCTIONS

In case of aggressive environmental conditions (high salinity, frost etc) we recommend to:

- remove showerheads, headworks and mixing cartridges during the cold season
- polish the entire shower column surface at least three times per year or three times during the seasonal use (beginning, half, end of summer)

INSTRUCTIONS SPÉCIALES

Dans le cas de conditions environnementales agressives (haute salinité, gélivité etc.) nous conseillons de :

- démonter pommes de douche, têtes et cartouches pendant la saison froide
- nettoyer toute la surface de la colonne au moins trois fois par année ou trois fois pendant la saison d'utilisation (début, moitié, fin d'été)

INSTRUCCIONES ESPECIALES

En ambientes externos agresivos (alta salinidad, hielo ecc) se aconseja:

- quitar rociadores, monturas y cartuchos cerámicos durante la temporada de frío
- limpiar toda la superficie de la columna al comienzo, a mitad y al final de la temporada

SONDERANLEITUNGEN

Im Umfeld aggressiver Umwelteinflüsse (starker Frost, Seeklima) wird empfohlen:

- die Brauseköpfe, Absperrventil und Handmischern komplett aufzuschrauben
- die Oberfläche der Duschsäule mindesten drei Mal pro Saison zu reinigen und zu polieren

fontealta
in&out steel concept

Rubinetteria F&F L'Artigiana srl
Via Libeccio 48/C
I-55049 Viareggio - Italy
T +39 0584 969041
F +39 0584 361206
www.fontealta.it
info@fontealta.it